

SECTION A-A

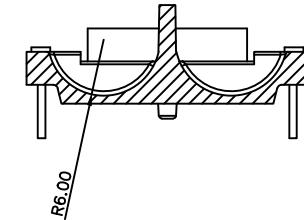

SECTION B-B

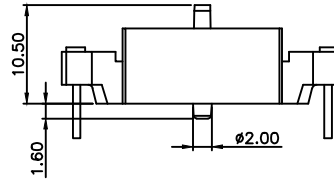
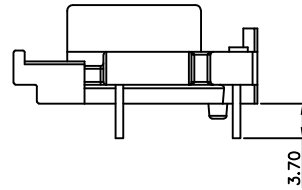
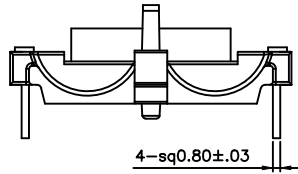
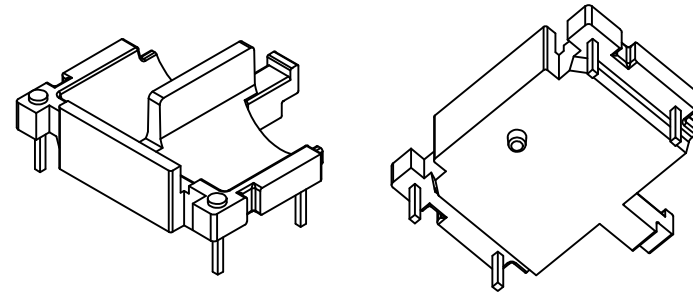
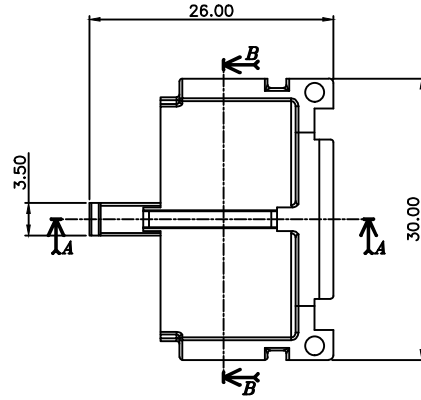
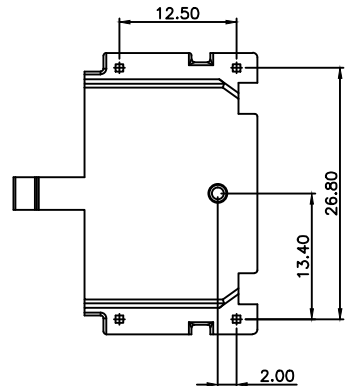

△								
△								
△								
△								
MARK	REVISION NOTE				DATE	DRAWN	CHECKED	APPROVED
DRAWN	CHECKED	APPROVED	MATERIAL : PHENOL(2736)	UL REC. : UL94V-0	THIRD ANGLE PROJ.	SCALE : 1/1		
GW, Jeon	KM, Kim	C, Park	Z : PIN LENGTH (According to customer's request)	DATE : 2014.08.20	TOLERANCE : ±0.2 (Unless otherwise specified)	UNIT : m/m		
주식회사 대흥보빈 DAE HEUNG BOBBIN CO., LTD			TITLE SQ 23*18 BASE (4P)			DWG NO DH-140911-4008-11		