

TOLERANCE	
0 ≤ L ≤ 4	±0.1
4 ≤ L ≤ 16	±0.2
16 ≤ L ≤ 50	±0.3
50 ≤ L ≤ 63	±0.4
63 ≤ L ≤ 75	±0.5
75 ≤ L ≤ 100	±0.7

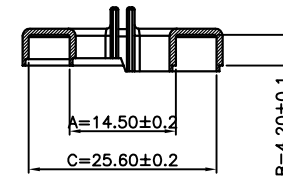

SECTION A-A

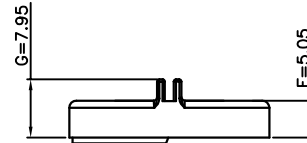
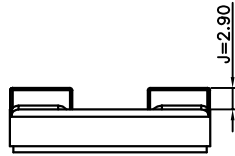
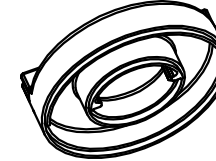
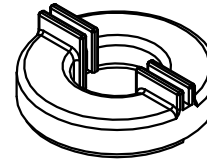
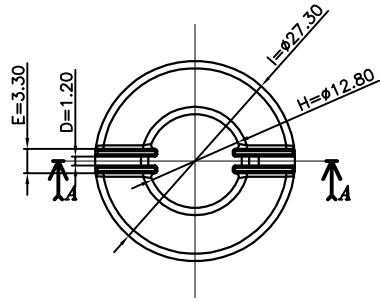
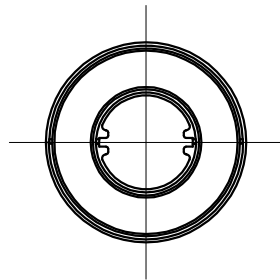

▲							
▲							
▲							
▲							
MARK	REVISION NOTE			DATE	DRAWN	CHECKED	APPROVED
DRAWN	CHECKED	APPROVED	MATERIAL : P.B.T (30%)	UL REC. : UL94V-0	THIRD ANGLE PROJ.	SCALE : 1/1	
MS, Kim	KM, Seo	C, Park	Z : PIN LENGTH (According to customer's request)	DATE : 2015.11.05	TOLERANCE : ±0.2 (Unless otherwise specified)	UNIT : m/m	
주식회사 대흥보빈 DAE HEUNG BOBBIN CO., LTD			TITLE OR 2508 CAP		DWG NO DH-151203-8656-00		