

TOLERANCE	
0 ≤ L ≤ 4	±0.1
4 ≤ L ≤ 16	±0.2
16 ≤ L ≤ 50	±0.3
50 ≤ L ≤ 83	±0.4
83 ≤ L ≤ 75	±0.5
75 ≤ L ≤ 100	±0.7

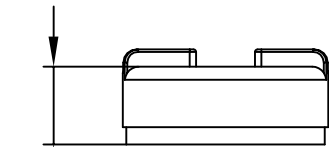

H=5.85

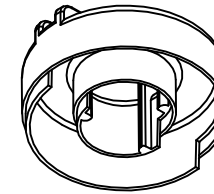
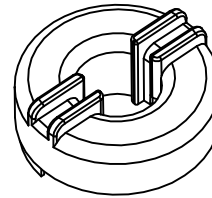
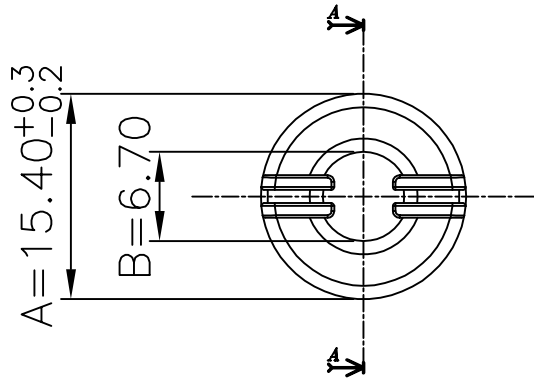
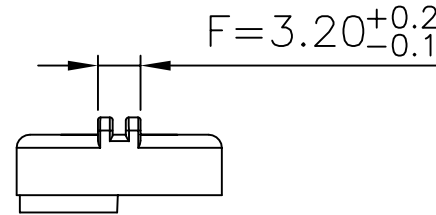
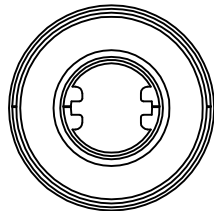

F=3.20<sup>+0.2</sup><sub>-0.1</sub>

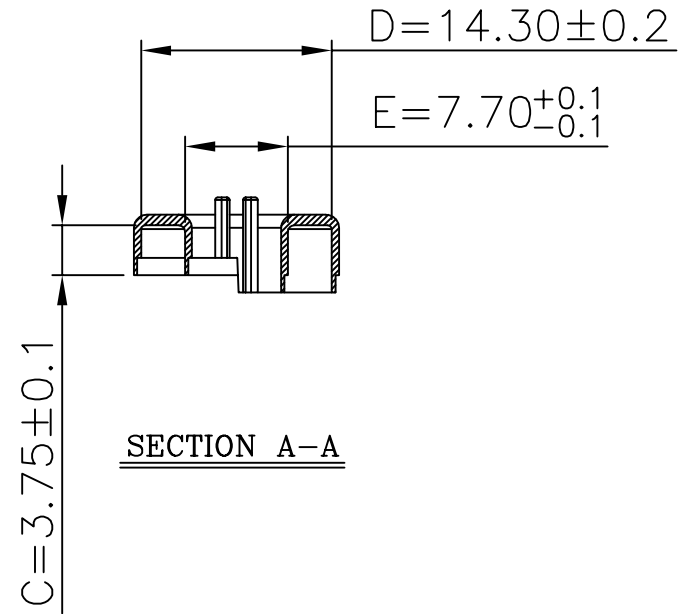

SECTION A-A

REVISION NOTE				DATE	DRAWN	CHECKED	APPROVED
MARK							
DRAWN	CHECKED	APPROVED	MATERIAL : PET	UL REC. : UL94V-0	THIRD ANGLE PROJ.	SCALE : 1/1	
MS, Kim	KM, Seo	C, Park	Z : PIN LENGTH (According to customer's request)	DATE : 2015.12.17	TOLERANCE : ±0.2 (Unless otherwise specified)	UNIT : m/m	
주식회사 대흥보빈 DAE HEUNG BOBBIN CO., LTD				TITLE OR 14φ CAP		DWG NO DH-160115-8661-00	