

SECTION A-A ( 7 )

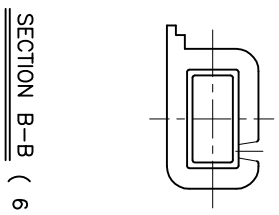

SECTION B-B ( 6 )

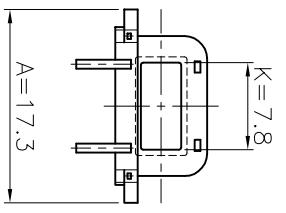
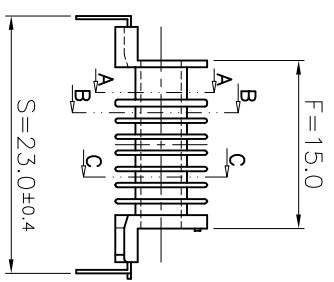
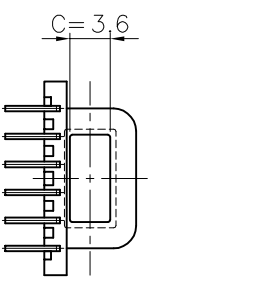
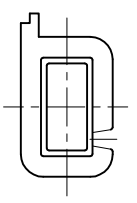
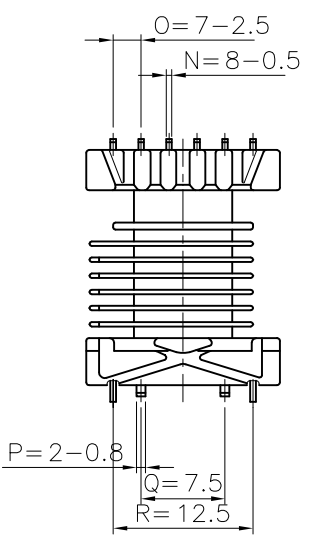

SECTION C-C ( 1,2,3,4,5 )

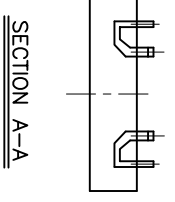

SECTION A-A

△									
△									
△									
△									
MARK		REVISION NOTE	DATE	DRAWN	CHECKED	APPROVED			
DRAWN	CHECKED	APPROVED	MATERIAL : L.C.P	UL REC. : U194V-0	DATE : 2003.08.04	THIRD ANGLE PROJ.	SCALE : 2/1		
Iho Soon, Moon		Jong Han, Lee							
<b>주식회사 대웅보빈</b> DAE HEUNG BOBBIN CO., LTD		TITLE EFD 18*20 8F (10P) (7차형)		DWG NO DH-030314-7000-01		TOLERANCE : ±0.2 (unless otherwise specified)		UNIT : mm	