

SECTION C-C

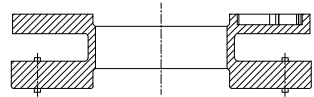

SECTION A-A

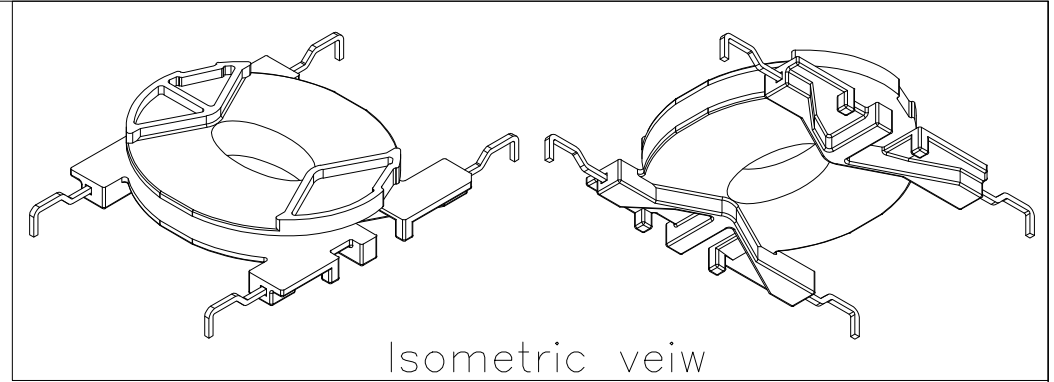
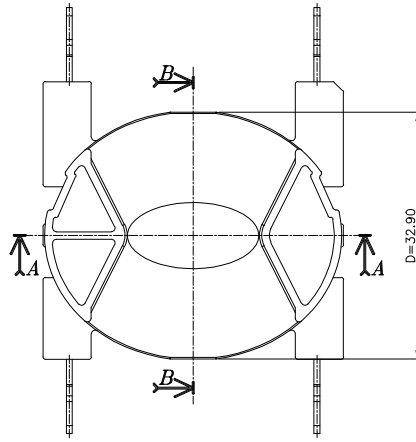
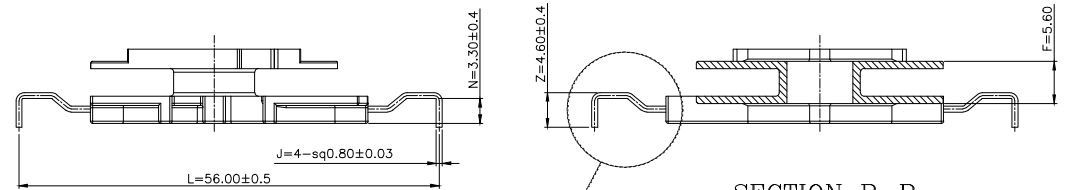
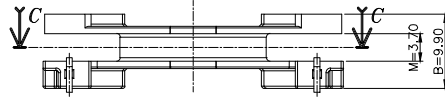

SECTION B-B

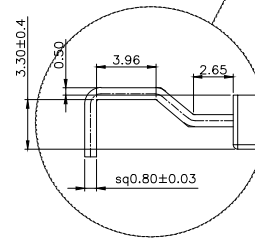
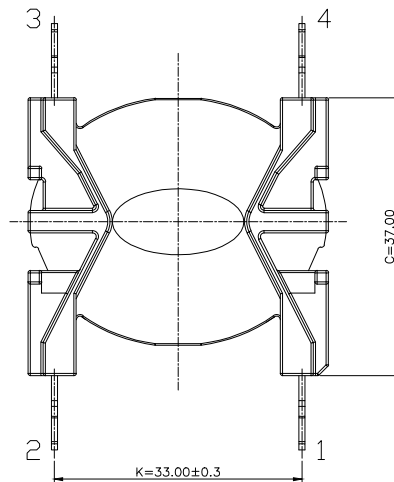

△							
△							
△							
△							
MARK	REVISION NOTE			DATE	DRAWN	CHECKED	APPROVED
	DRAWN	CHECKED	APPROVED	MATERIAL : PHENOL	UL REC. : UL94V-0	THIRD ANGLE PROJ.	SCALE : 1/1
	DS, Kim	HS, Lee	JB, Lim	DATE : 2010.10.06	TOLERANCE : ±0.2 (Unless otherwise specified)		UNIT : m/m
주식회사 대흥보빈 DAE HEUNG BOBBIN CO., LTD				TITLE PQ 38B*12 (4P) "V"		DWG NO DH-101027-6028-17	