

DETAIL "C" X 4

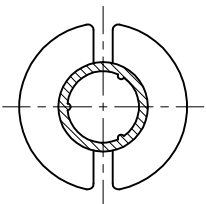

SECTION B-B'

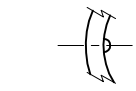
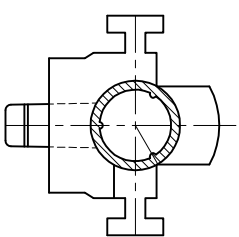

SECTION A-A'

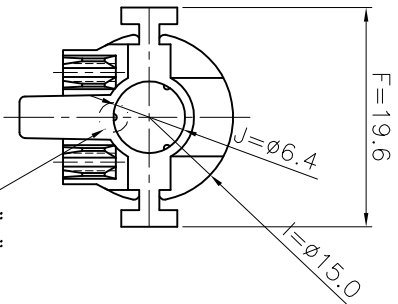
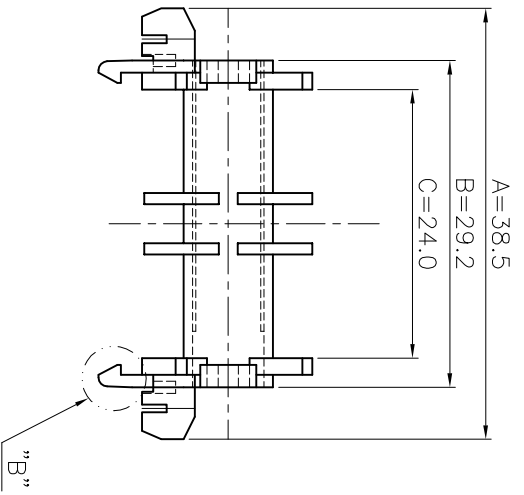

DETAIL "A" X 4

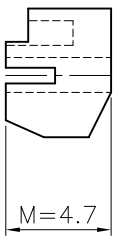

DETAIL "B" X 4

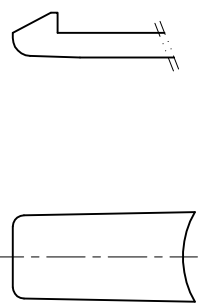

| | | | | | | | | | |
|---------------------------|---------|---------------|-----------------------------------|-------------------|------------------------------|-------------------|--|--|--|
| △ | | | | | | | | | |
| △ | | | | | | | | | |
| △ | | | | | | | | | |
| △ | | | | | | | | | |
| MARK | | REVISION NOTE | DATE | DRAWN | CHECKED | APPROVED | | | |
| DRAWN | CHECKED | APPROVED | MATERIAL : NORYL | UL REC. : US94V-0 | THIRD ANGLE PROJ. | SCALE : 2/1 | | | |
| 이보 소, 문 | | 정근, Lee | | | | | | | |
| TITLE | | | Z : PIN LENGTH | DATE : 2003.03.13 | TOLERANCE ±0.2 | UNIT : mm | | | |
| | | | (According to customer's request) | | (unless otherwise specified) | | | | |
| DAE HEUNG BOBBIN CO., LTD | | | 17" | SUPER BALANCE | DWG NO | DH-030312-6020-01 | | | |