

SEC D

SEC A

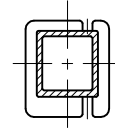
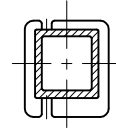
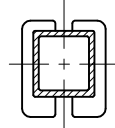

SEC E

SEC B

SEC C

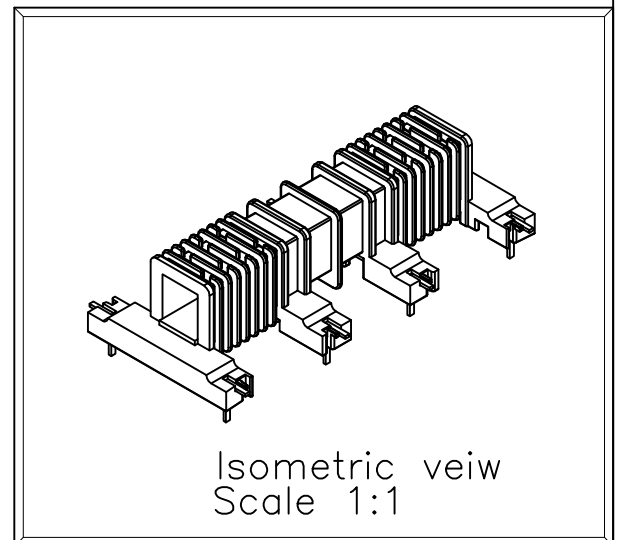
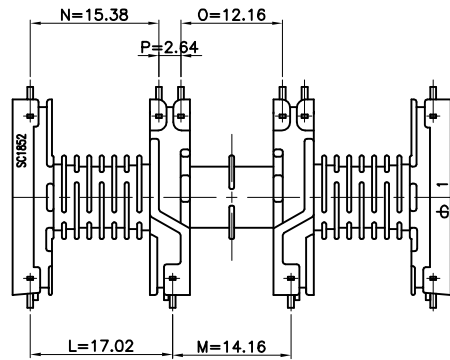
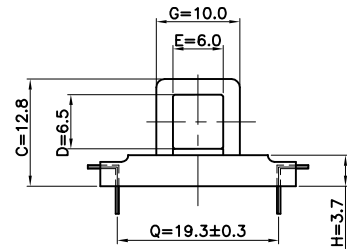
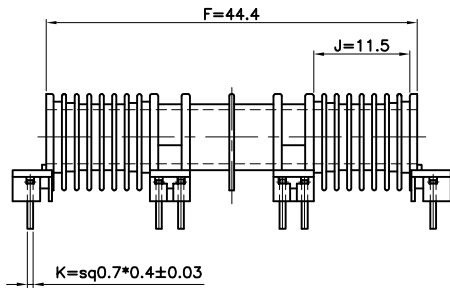

④							
③							
②							
①							

MARK REVISION NOTE DATE DRAWN CHECKED APPROVED

DRAWN	CHECKED	APPROVED	MATERIAL : PET	UL REC. : UL94V-0	THIRD ANGLE PROJ.	SCALE : 1/1
Dae Soo, Kim	Hyoung Seok, Lee	Chul, Park	Z : PIN LENGTH (According to customer's request)	DATE : 2008.03.13	TOLERANCE : ±0.2 (Unless otherwise specified)	UNIT : m/m
주식회사 대흥보빈 DAE HEUNG BOBBIN CO., LTD			TITLE EE 18*52 (10P) "H"		DWG NO DH-080313-2005-05	